

North West Wales Dendrochronology Project Plas y Dduallt, Maentwrog, Gwynedd



**EAS Client Report 2011/16
September 2011**

**Engineering Archaeological Services Ltd
Unit 2 Glanypwll Workshops
Ffordd Tanygrisiau
Blaenau Ffestiniog
Gwynedd
LL41 3NW**

Registered in England N° 286978



**North West Wales Dendrochronology Project
Plas y Dduallt, Maentwrog,
Gwynedd**

EAS Client Report 2011/16

**Commissioned by
Margaret Dunn
For
North West Wales Dendrochronology Project**

September 2011

**By
I.P. Brooks**

**Engineering Archaeological Services Ltd
Unit 2 Glanypwll Workshops
Ffordd Tanygrisiau
Blaenau Ffestiniog
Gwynedd
LL41 3NW**

Registered in England N° 286978

Content

Grid Reference

NPRN Number

Status

Introduction

Methodology

Survey Report

Dendrochronology Sampling

Conclusions

Acknowledgements

References

Appendix 1: Sources

List of Figures

Figure 1: Location

Figure 2: Extract from the 1889, First Edition Ordnance Survey 1:2500 map Merionethshire XI.8

Figure 3: Cellar Plan

Figure 4: Ground Floor Plan

Figure 5: First Floor Plan

Figure 6: Attic Plan

Figure 7: Truss 1

Figure 8: Trusses 2 and 3

Figure 9: Truss 4

Figure 10: Location of the photographs in the archive (Cellar and Ground Floors)

Figure 11: Location of the photographs in the archive (First and Attic Floors)

List of Plates

Plate 1: General view of Plas y Dduallt

Plate 2: The north eastern elevation of the southern range

Plate 3: The south eastern elevation of the southern range

Plate 4: The south western elevation of the southern range

Plate 5: The front elevation of the lobby

Plate 6: The rear elevation of the lobby

Plate 7: The front elevation of the northern range.

Plate 8: The south eastern elevation of the northern range

Plate 9: The kitchen extension
Plate 10: The agricultural range
Plate 11: The cellar steps
Plate 12: The cellar ceiling
Plate 13: The corbel supporting the transverse beam in the cellar
Plate 14: The “doorway” between the two cellars
Plate 15: The passage cellar
Plate 16: The chimney breast in the parlour
Plate 17: Chamfer and stops on ceiling beams of the parlour
Plate 18: The chamfer and stop on the transverse beam in the parlour
Plate 19: Mortice holes for joists in the parlour
Plate 20: Mortice holes for the partition in the parlour
Plate 21: The corbelled support for the longitudinal beams in the parlour
Plate 22: The intra mural staircase
Plate 23: The initials on the window mullion
Plate 24: The daisy wheel
Plate 25: The graffiti on the window cill
Plate 26: The window between the staircase and the lobby
Plate 27: First floor access to the staircase
Plate 28: The first floor corridor in the parlour block
Plate 29: The first floor bedroom in the parlour block
Plate 30: The joists in the first floor bedroom of the parlour block
Plate 31: The beams in the first floor bedroom of the parlour block
Plate 32: The carved lintel over the blocked fireplace.
Plate 33: The carving on the cap of the attic newel post
Plate 34: Truss 2
Plate 35: Mortice for the missing collar Truss 1
Plate 36: Trenching for the purlin in the attic
Plate 37: The later doorway between the attic bedroom and the storage space
Plate 38: The north eastern end of the hall
Plate 39: The bressumer
Plate 40: The south western end of the hall
Plate 41: Stone pillar supporting the transverse beam
Plate 42: Vertical timber partly within the wall in the hall
Plate 43: End of a transverse beam in the hall
Plate 44: The joists in the hall
Plate 45: Stairs to the bedroom in the hall block
Plate 46: Truss 3
Plate 47: Part of the partition below Truss 3
Plate 48: Door head cut into the collar of Truss 3
Plate 49: Truss 4
Plate 50: Chamfered edges to Truss 4
Plate 51: Trough for missing purlin, Truss 4
Plate 52: The rear of Truss 4 showing possible sooting

North West Wales Dendrochronology Project

Plas y Dduallt

SH 67322 41822

Listed Building Reference: 4703

NPRN 28336

PRN 4703

Introduction

This report details the recording of the house Plas y Dduallt, Maentwrog, Gwynedd, undertaken to compliment both the dendrochronological sampling, undertaken by Oxford Dendrochronology Laboratory, and the documentary study undertaken by volunteers for the North Wales Dendrochronology Project. The fieldwork took place on 7th and 8th September 2011.

Methodology

Plans of all floors were made by direct measurement. The drawings of the timberwork were carried out by direct measurement at a scale of 1:20. Photographs were taken with a Nikon D80 digital SLR camera at a resolution of 10.2 mega pixels. Where practical all the photographs included a metric scale.

Survey Report

Plas y Dduallt is located on the southern slopes of Moel Dduallt, overlooking the Vale of Ffestiniog and the Afon Dwyryd. At an approximate elevation of 147 m OD the house is approximately 3.25 km NE of Maentwrog. The house is mentioned in Smith (1975, 1988, 167, 178) and has a brief description in Haslam *et al* 2009 (675) and Smith 2001 (458, 504). The property is known to have been extensively restored by Colonel Cambell, in the 1960's (<http://www.snowdoniamanor.co.uk/history/campbell.htm>)

The core of the house has two parallel wings linked with a storey and a half lobby (Plate 1). To this is attached an agricultural wing to the north, a kitchen to the west and a cellar extension to the south. The southern wing is a two and a half storey building aligned approximately north-east to south-west. Constructed of poorly coursed stone, it has two, stone built, gable end chimneys and a slate roof with ceramic ridge tiles. The north eastern elevation has two windows on each storey (Plate 2). Three of the windows on the first two floors match with heavy wooden mullions and transoms, whilst the fourth is a modern replacement. Those windows in the attic space have plain, diamond, wooden mullions. The south eastern elevation sits over the later cellar extension (Plate 3). It has two centrally placed windows which have three lights separated by wooden mullions. The lower window has a stone hood mould. There is also a doorway with an arched head and small stone

voussoirs, but no keystone. Below the main house is an extension to the cellar of poorly coursed slabby construction with mock arrow slot windows. The south western elevation (Plate 4) has a single window lighting the cellar, another for the ground floor and two lighting the first floor. All of the windows are relatively small in size, particularly those giving light to the first and ground floors. The ground floor window has a series of wooden mullions as does the cellar window, whilst the first floor windows are single pane casement windows with leaded lights

The lobby has double door under a depressed arched with stone voussoirs (Plate 5). Above this is a triangular planned, oriel window with leaded lights. The rear elevation has a single six pane window with leaded lights on the ground floor and dormer with a two pane leaded window (Plate 6).

The northern wing is a storey and a half block with gable end chimneys and a slate roof with ceramic ridge tiles. It is constructed of slabby stone blocks, roughly coursed, with no emphasis at the quoins. The front elevation (Plate 7) has a single small window set low on the ground floor below which is a letter-box. There is a straight joint to the agricultural range to the north west and a later, small buttress, which obscures the base of this joint. The south eastern elevation (Plate 8) has a large window with six, leaded panes on the ground floor, adjacent to the front door. Above is a smaller, three pane window within a dormer. Both of the windows have wooden mullions and the lower window also has a wooden transom. At the north eastern foot of the wall there is a large rounded boulder with a series of small slabby stones which is distinct from the construction style of the main wall. Whilst it is possible that this is part of the foundations of the house it appears to be distinct and therefore may hint at an earlier structure.

To the rear of the northern range, there is a later, kitchen range (Plate 9). This is constructed of roughly coursed stonework. There is a change in the stonework on the rear wall which is associated with the large, arched window. The later stonework is of smaller stones and its position, and relationship to the earlier stonework, suggests that much of the gable end has been replaced.

The agricultural range (Plate 10) has been largely converted into holiday accommodation, although access to the first floor rooms of the northern range is via the south eastern end of the agricultural range. The converted section of the agricultural range is not part of this study.

Inside; the southern range has a cellar (Figure 3), ground floor parlour, first floor and attic bedrooms. The cellar is accessed from the lobby via a straight flight of stone steps (Plate 11) and had two windows in the south eastern wall. One gives light to the cellar head at ground floor level, whilst the other lights the main body of the cellar. There are two elements to the cellar, the main body and a passageway along the north eastern side. The main body of the cellar appears to be original and has the timberwork for the floor of the parlour above exposed (Plate 12). The main beam whilst embedded in the wall at its north western end is supported by a stone corbel at the south eastern end (Plate 13). The passageway is clearly later in date. It is accessed from the

main cellar via a splayed doorway (Plate 14) cut through the main cellar wall. The passage (Plate 15) leads to an external doorway and has a series of splayed, narrow slot type windows.

The parlour (Figure 4) has a stone built chimney breast at the north western end of the room (Plate 16). The ceiling has a main lateral beam and two longitudinal beams, but no joists. All of the beams are chamfered and stopped with straight cut stops (Plates 17 and 18). There is evidence, however that there were joists in the south eastern end of the room (Plate 19), but these have since been removed. There is also evidence that there was a partition below the western end of the northern longitudinal beam with a series of mortice holes on the underside of this beam (Plate 20). The western end of the longitudinal beam is supported by a corbelled support (Plate 21) consisting of a large stone beam supported by three corbelled blocks. On the north western wall there are two doorways, with arched doorheads formed with stone voussoirs with no keystone, whilst one of which gives access to the lobby, the other gives access to a stone stair case (Plate 22). The south eastern window frame has a series of graffiti on both the cill and mullion. On the mullion there are a series of initials above a daisy wheel (Plate 23). The initials are "I LL", below which is the letter "W" with a horizontal line. Below this is "RH II" and then an "I". At the bottom of the mullion is a daisy wheel design (Plate 24). On the cill are a scratched shield and the initials "RH II" (Plate 25).

The staircase has stone steps forming a winder staircase to the first floor. There are two windows lighting the staircase, the lower of which gives light from the lobby. This window has a diamond mullion, glazing stanchions and a heavy frame (Plate 26). The relationship between the parlour block and the lobby is not entirely clear. The lower window of the staircase may suggest that the lobby is a later feature linking the two ranges. If so, the staircase is contained by an external stair tower, however this would mean that the access to the cellar would have been via an external door.

The staircase reaches the first floor (Figure 5) of the parlour range through an arched opening with stone voussoirs and no keystone (Plate 27). There is a corridor which links to the first floor of the lobby (Plate 28). Off this corridor is a bedroom, the access to attic, a cupboard and a bathroom. The bedroom has a timbered ceiling with two transverse beams supporting a series of joists (Plate 29). Both the joists (Plate 30) and the beams (Plate 31) are chamfered and stopped with straight cut stops. At the south western end of the bedroom, there is a partly blocked fireplace with a carved wooden lintel (Plate 32). This lintel is part of the restoration of the property carried out in the 1960's by Colonel Campbell

The attic (Figure 6) was accessed by a steep flight of wooden stairs. One of the newel post at the head of the stairs, appears to have a design carved into its cap (Plate 33). This would appear to be two crossed "P" designs. The attic has two trusses (Figures 7 and 8). Both Trusses 1 (Plate 34) and 2 are relatively simple trusses with straight principal rafters which are lapped. Whilst Truss 2 retains its collar, Truss 1 has had the collar removed to allow the space to be used as a bedroom (Plate 35). There are two pairs of purlins which were originally trenched, although there are now packing pieces which

have slightly raised the level of the roof (Plate 36). Below Truss 2 there is a partition dividing the attic into a bedroom and a storage area. There is a doorway between the two spaces (Plate 37) which has been clearly added at a later date.

The ground floor of the hall block (northern range) consists of a single room with large, partly blocked, hearth at the north eastern end (Plate 38). There is a large bressumer (Plate 39) which defines the extent of the original fireplace. The south western end of the hall (Plate 40) gives access the kitchen. The ceiling has two transverse beams crossing the room together with two further transverse beams at each gable end. The western beam is supported by stone pillars which are slightly corbelled (Plate 41). This beam is slightly lighter than the other transverse beams and may be a replacement. Partly hidden by the end of this beam and largely encased within the walls are vertical timbers which are assumed to be the extensions of the principal rafters for the cruck truss above (Plate 42). The beams are chamfered and have run out stops (Plate 43), whilst the joists are also chamfered and have straight cut stops (Plate 44).

The first floor bedroom has doorways linking the bedroom to the first floor of the lobby and to the northern end of the attached range which is assumed to originally be agricultural. There is a short, curved, stone staircase from the agricultural range which gives access to the northern corner of the bedroom (Plate 45). There are two trusses within the bedroom; both have cruck principal rafters, a collar and raked struts. Truss 3 (Figure 8.2) has a partly open partition below the collar (Plate 46). Whilst most of this partition is formed by a series of upright struts with depressed point arches between the uprights, the flanking sections have been boarded between the struts (Plate 47). The central section forms a doorway between two sections of the bedroom. The door head has been formed by cutting into the collar with a cranked door head (Plate 48). The partition is clear later than the truss above and may date to the 1960's renovation. There may have been a partition above the collar as there are three mortice holes on the underside of the principal rafter (Plate 49). The truss also appears to have been finish to a higher degree on its south western face with the north eastern face being left partly with its original curved surface. Truss 4 similarly appears to have one finished face. The south western face is not only flat, but the struts and principal rafters have slight chamfers and run out stops (Plate 50). There is only one pair of purlins surviving; however Truss 4 has troughs for lower purlins which are no longer in use (Plate 51). The rear of Truss 4 (Plate 52) has slight darkening which may be the remains of sooting on these timbers.

Dendrochronology Sampling

A total of seventeen samples were taken, by Oxford Dendrochronology Laboratory (Miles and Bridge 2011) from both of the main ranges. Twelve samples were taken from the northern range and five from the southern range. These samples suggest that the northern range was in its present form by the late 1560's, whilst the southern range was probably constructed in, or shortly after, 1605.

Conclusions

The dendrochronological dating of the two main wings of Plas y Dduallt (Miles and Bridge 2011) demonstrates that they were constructed at different times with the parlour block being constructed some forty to fifty years later than the hall range. The evidence is equivocal as to whether the linking lobby was constructed at the same time as parlour block, but it is probably contemporary.

The hall has a cruck frame which has been slightly modified with the removal of the lower purlins to allow doorways, both from the first floor lobby room and the agricultural range. There is some evidence that this may have originally been an open hall. Both of the trusses have finished faces which look south west and there is possibly some sooting on the rear of Truss 4. The cruck blades of Truss 4 also appear to extend into the ground floor where they are partly encased in the stone walls. This early open hall however is not necessarily confirmed by the dendrochronological dating which is equivocal possibly suggesting an extended period of construction within the 1560's (Miles and Bridge 2011).

The 1960's restoration and modifications probably included the extension of the cellar and the restoration of the kitchen range to the south west of the hall. It also saw several cosmetic changes including the partition below Truss 3 and the lintel above the fireplace in the first floor bedroom of the parlour range.

Acknowledgments

The recording of this building was commissioned by Margaret Dunn for the North Wales Dendrochronology Project. Thanks are also due to the Huw Jenkins and Sue Farrand for access to this building.

References

- Haslam, R., Orbach, J. and Voelcker, A. 2009. *The Buildings of Wales. Gwynedd*. Yale University Press, London
- Miles, D. and Bridge, M. 2011 *The Tree-Ring Dating of Plas y Dduallt, Tan y Bwlch, Maentwrog, Gwynedd* Oxford Dendrochronology Laboratory Report 2011/5
- Smith, P. 1988, *Houses of the Welsh Countryside. A study in historical Geography (Second enlarged edition)*. HMSO, London
- Smith, P. 2001. Houses c.1415 – c.1642. In Beverley Smith, J and Beverley Smith (eds.), *L History of Merioneth. Volume II. The Middle Ages*. Cardiff University Press, Cardiff. 422 – 506

<http://www.snowdoniamanor.co.uk/history/campbell.htm> (Accessed 4/10/11)



Plate 1: General view of Plas y Dduallt



Plate 2: The north eastern elevation of the southern range



Plate 3: The south eastern elevation of the southern range



Plate 4: The south western elevation of the southern range



Plate 5: The front elevation of the lobby



Plate 6: The rear elevation of the lobby



Plate 7: The front elevation of the northern range.



Plate 8: The south eastern elevation of the northern range



Plate 9: The kitchen extension



Plate 10: The agricultural range



Plate 11: The cellar steps



Plate 12: The cellar ceiling



Plate 13: The corbel supporting the transverse beam in the cellar



Plate 14: The “doorway” between the two cellars



Plate 15: The passage cellar



Plate 16: The chimney breast in the parlour



Plate 17: Chamfer and stops on ceiling beams of the parlour



Plate 18: The chamfer and stop on the transverse beam in the parlour



Plate 19: Mortice holes for joists in the parlour



Plate 20: Mortice holes for the partition in the parlour



Plate 21: The corbelled support for the longitudinal beams in the parlour



Plate 22: The intra mural staircase



Plate 23: The initials on the window mullion



Plate 24: The daisy wheel



Plate 25: The graffiti on the window cill



Plate 26: The window between the staircase and the lobby



Plate 27: First floor access to the staircase



Plate 28: The first floor corridor in the parlour block



Plate 29: The first floor bedroom in the parlour block



Plate 30: The joists in the first floor bedroom of the parlour block



Plate 31: The beams in the first floor bedroom of the parlour block

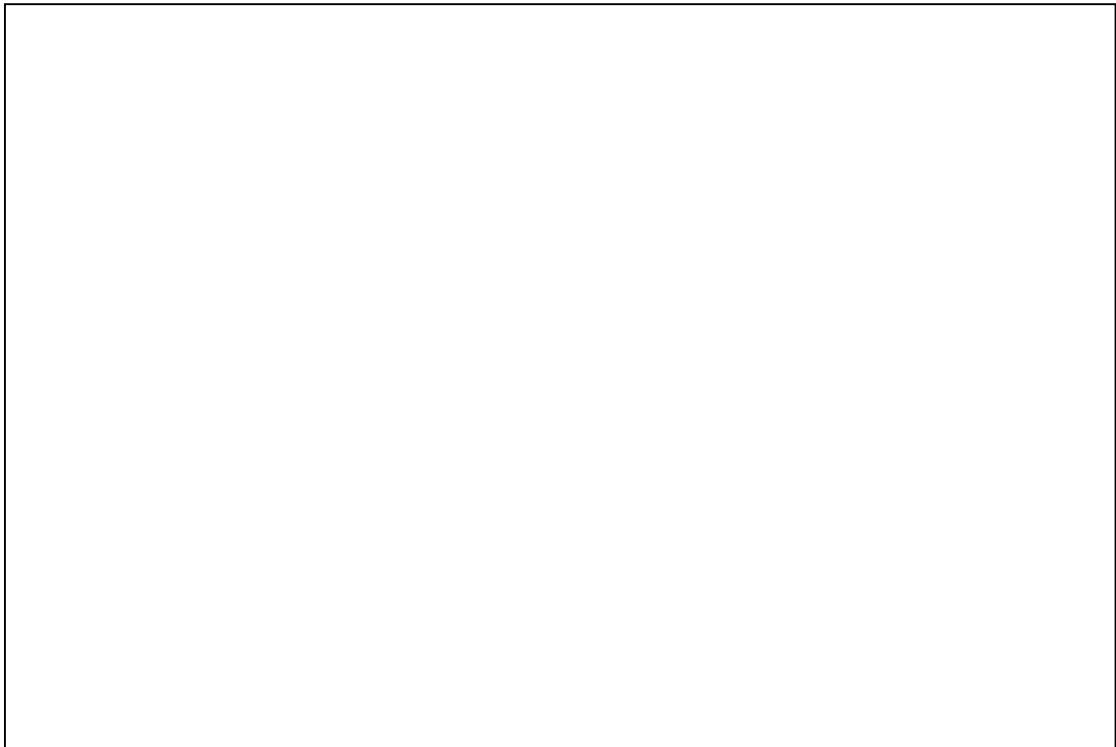

Plate 32: The carved lintel over the blocked fireplace.

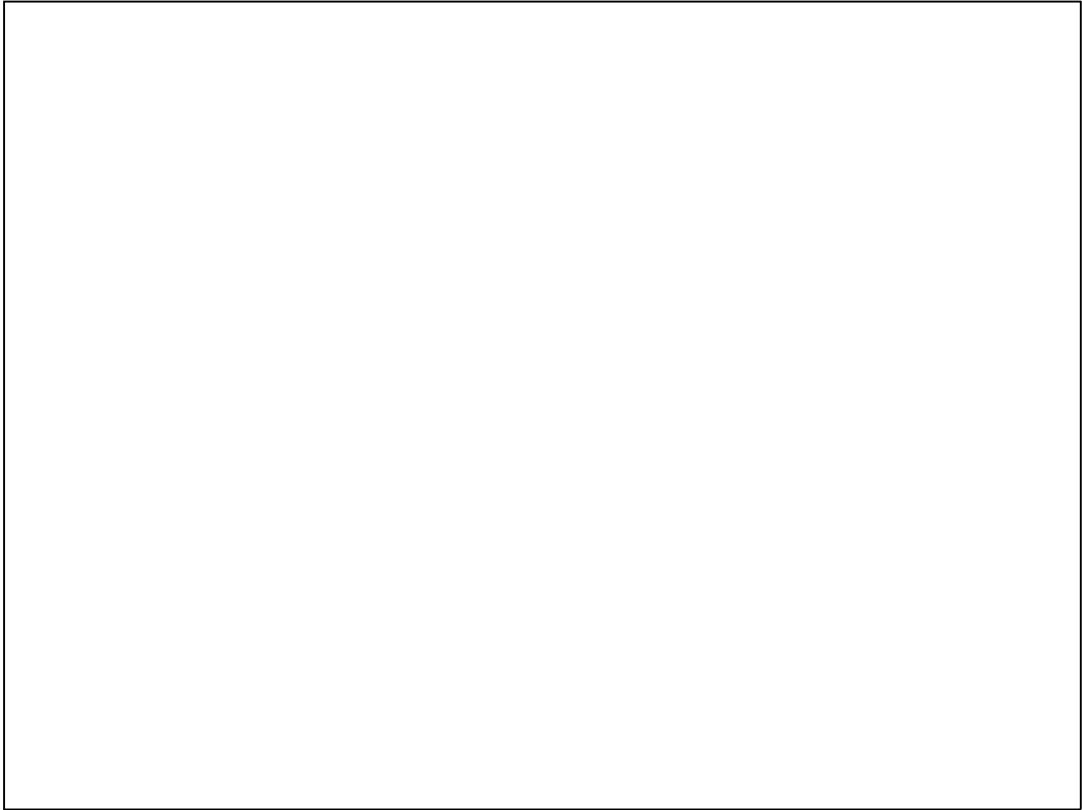

Plate 33: The carving on the cap of the attic newel post

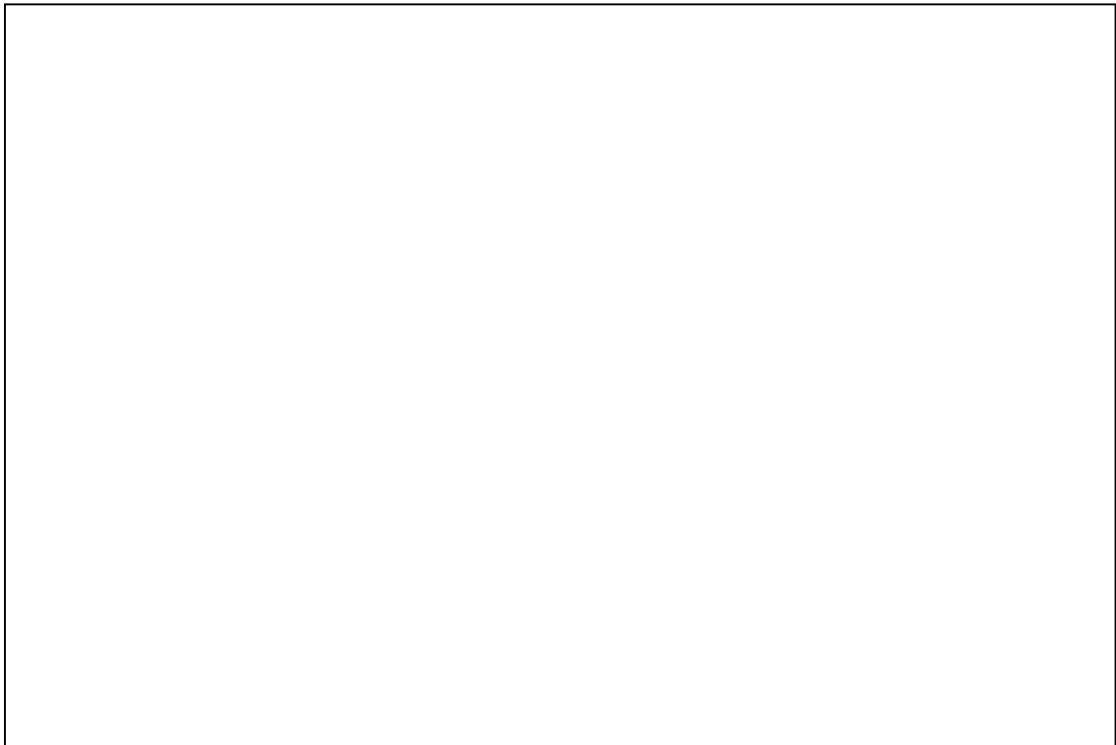

Plate 34: Truss 2

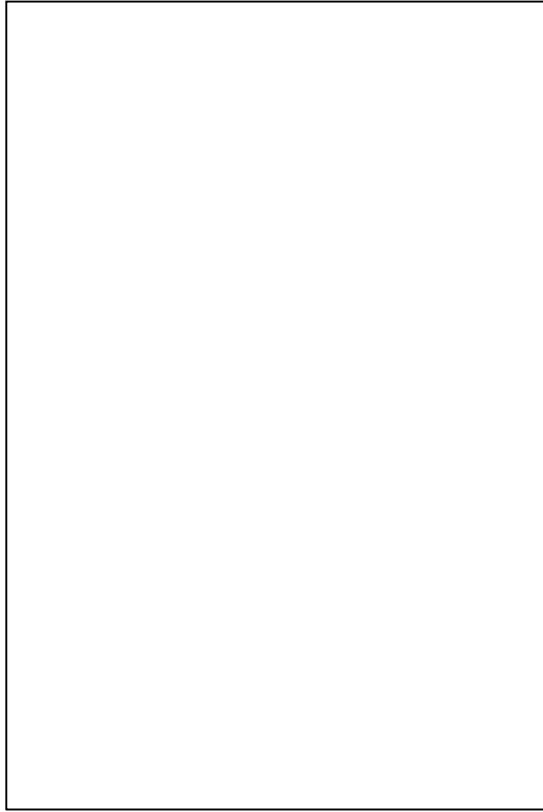

Plate 35: Mortice for the missing collar Truss 1

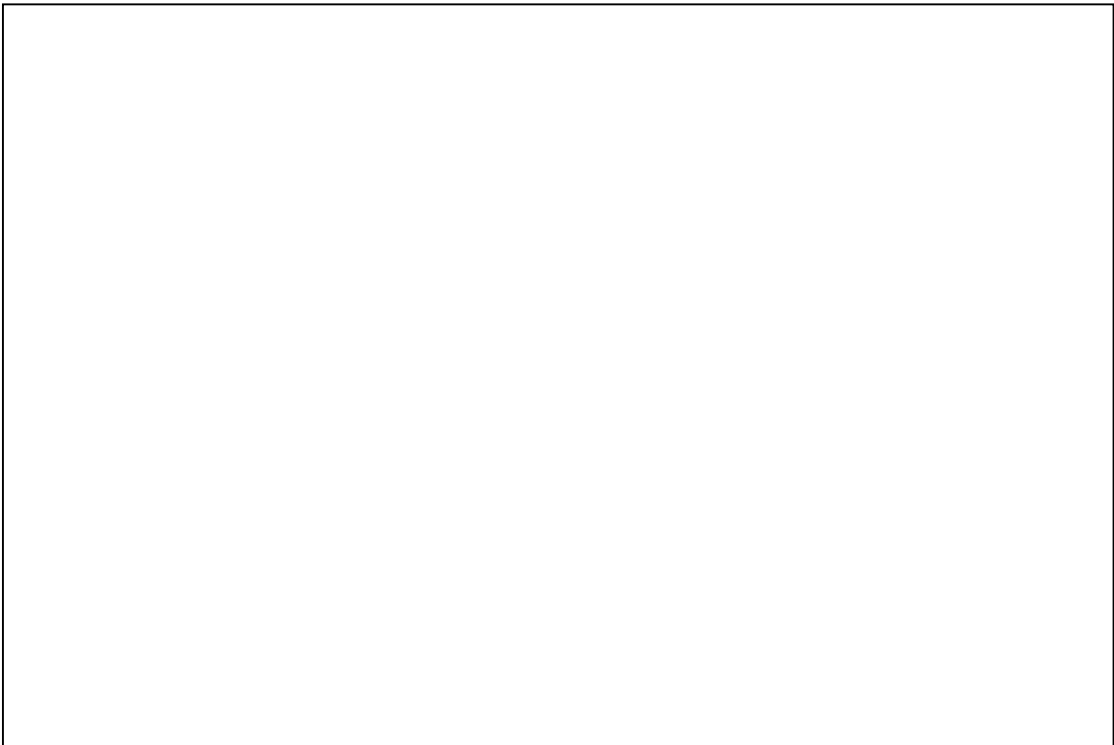

Plate 36: Trenching for the purlin in the attic

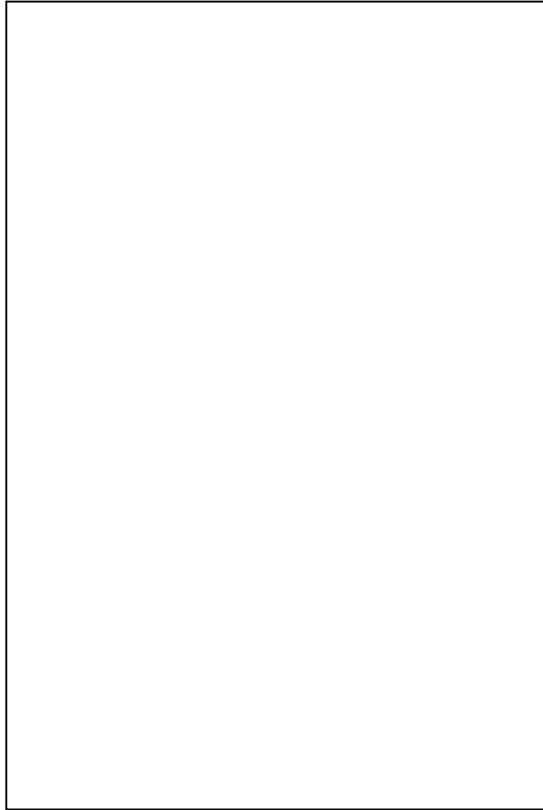

Plate 37: The later doorway between the attic bedroom and the storage space



Plate 38: The north eastern end of the hall

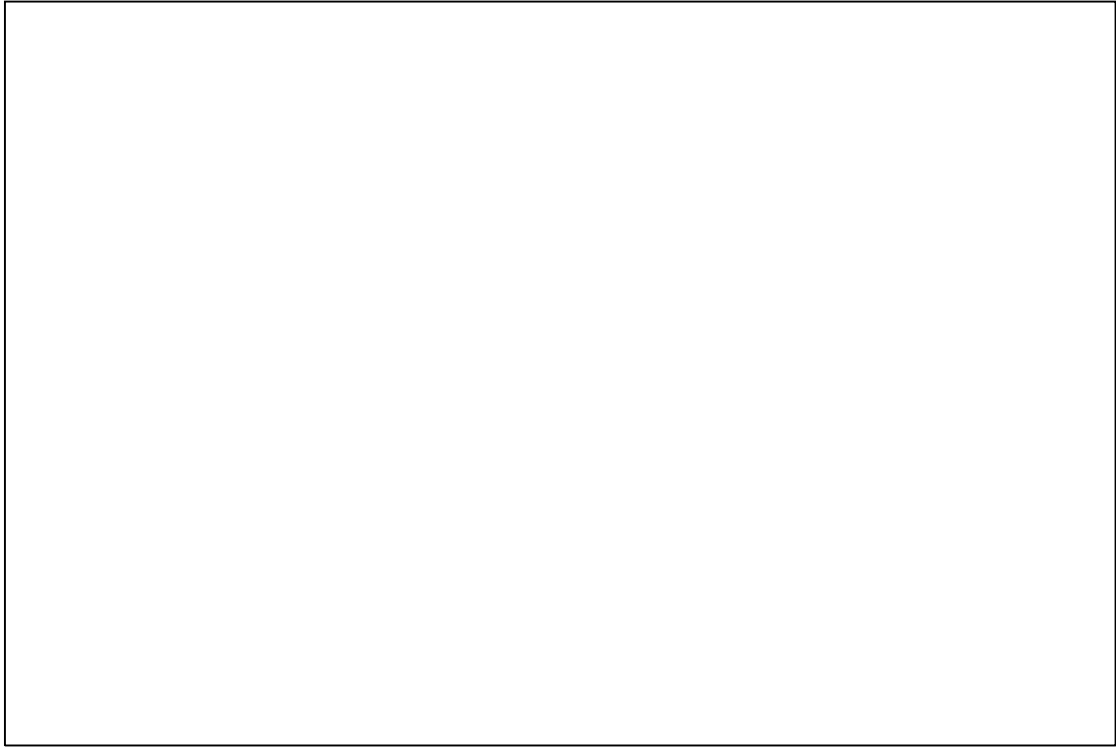

Plate 39: The bressumer

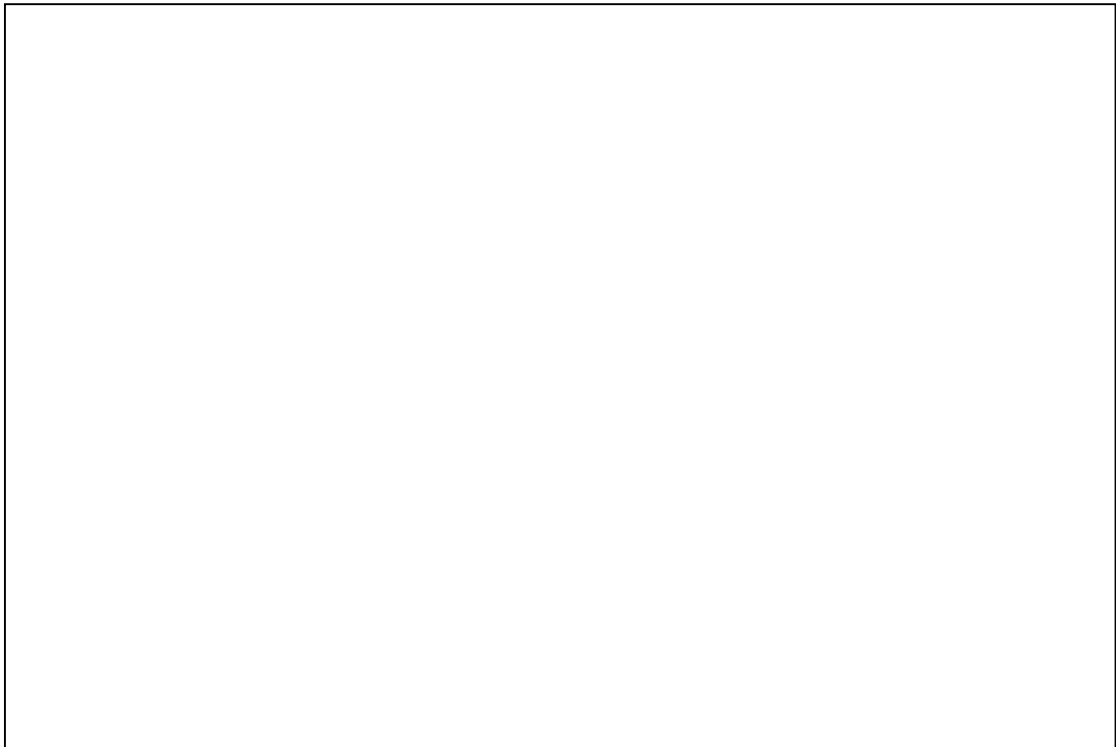

Plate 40: The south western end of the hall

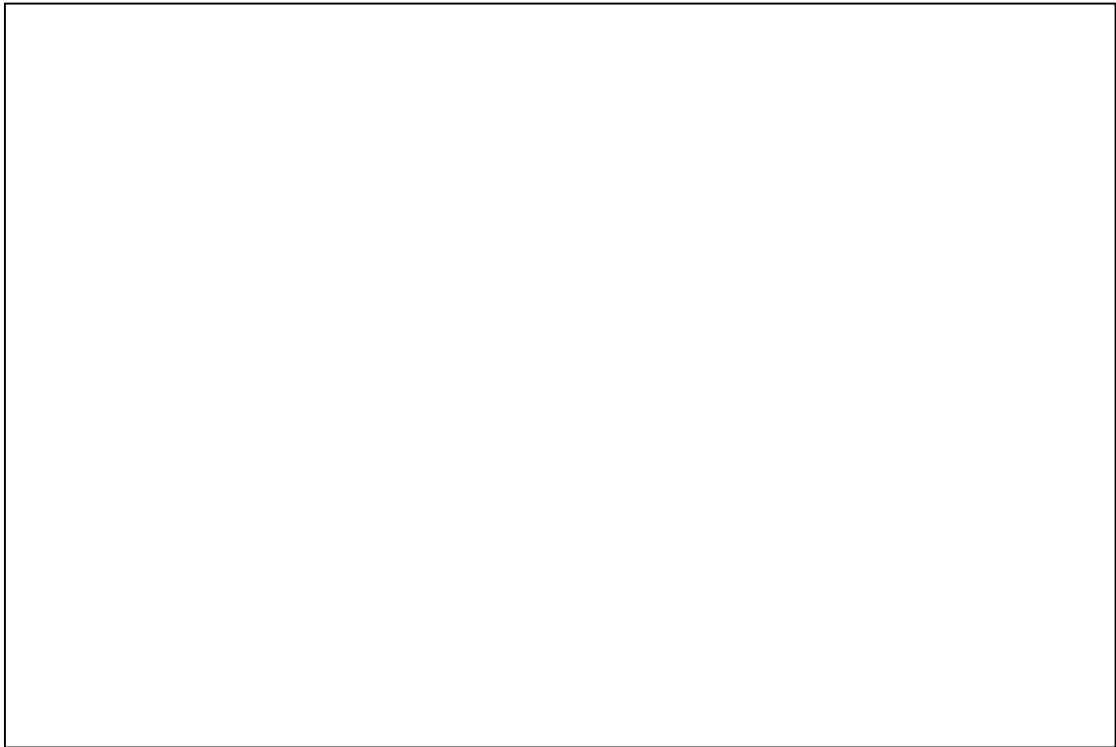

Plate 41: Stone pillar supporting the transverse beam



Plate 42: Vertical timber partly within the wall in the hall

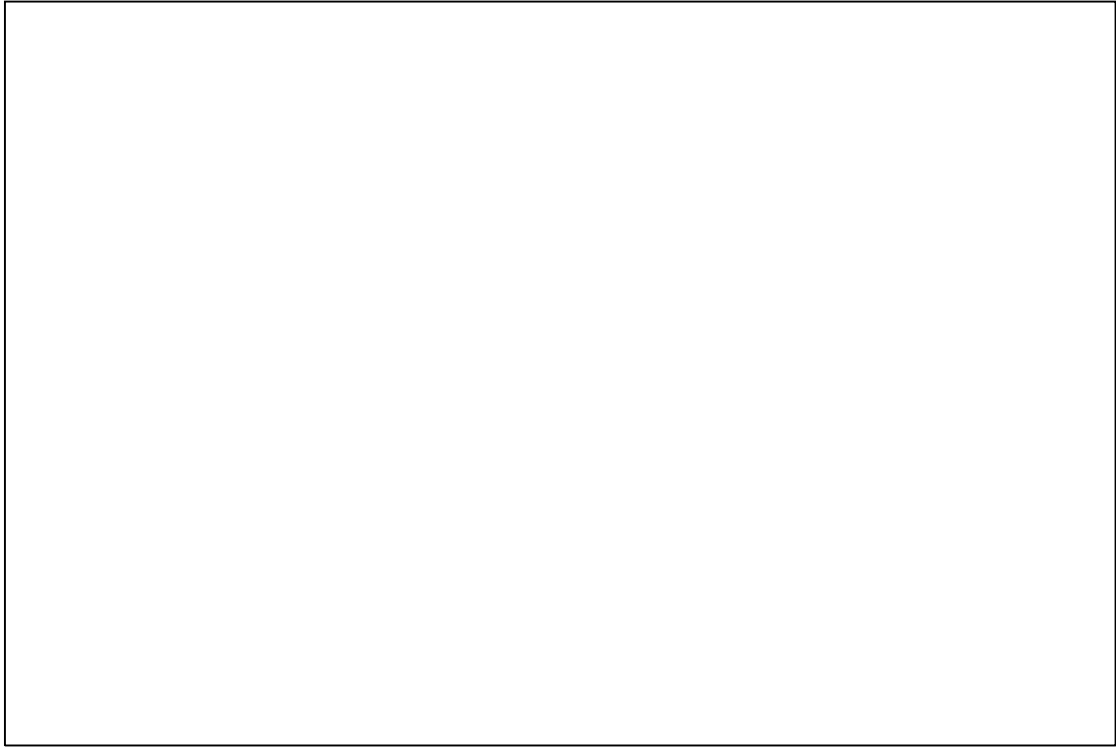

Plate 43: End of a transverse beam in the hall

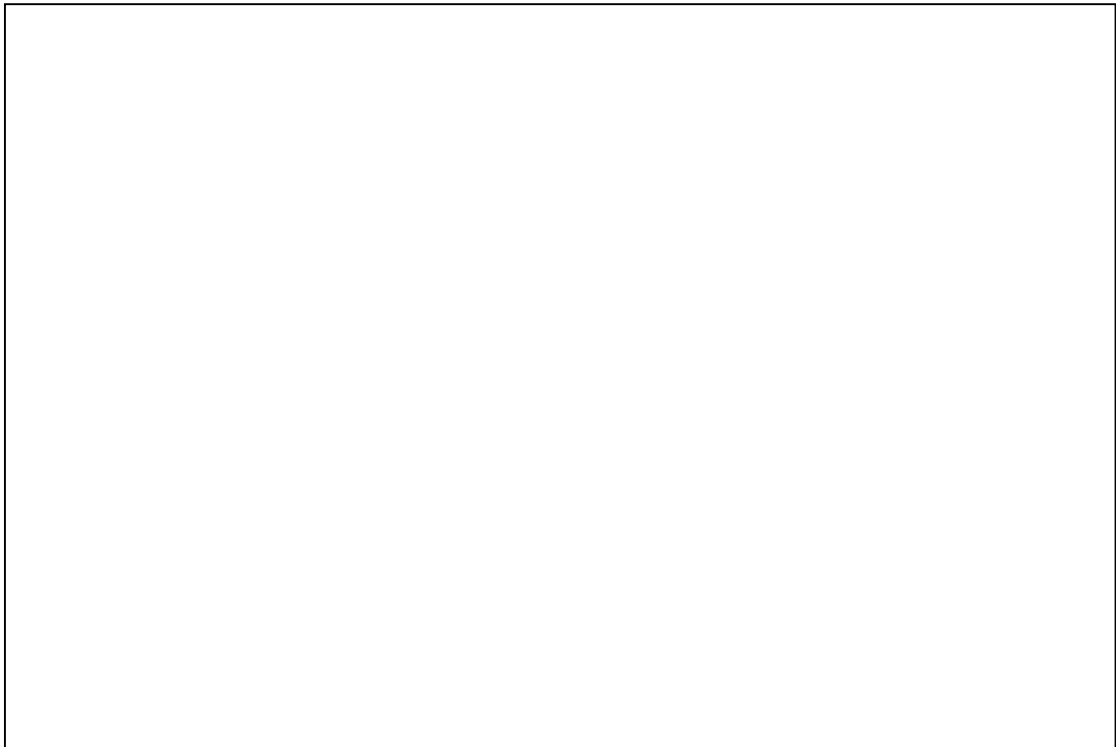

Plate 44: The joists in the hall

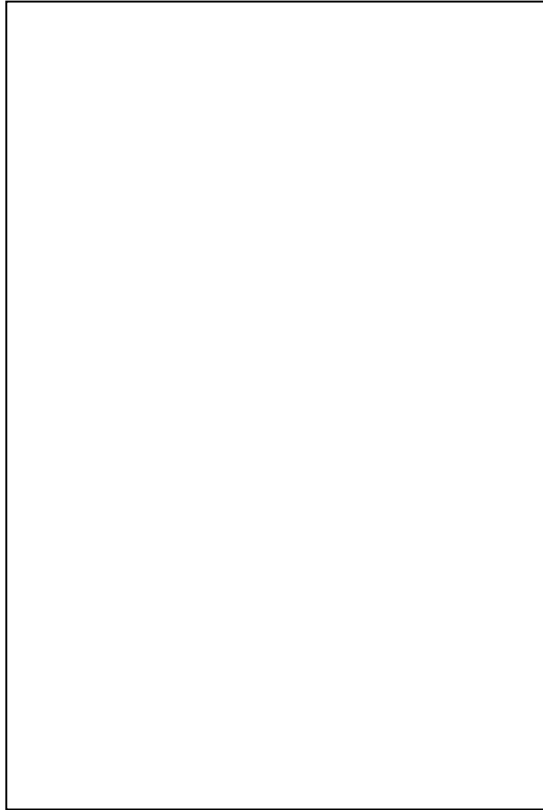

Plate 45: Stairs to the bedroom in the hall block

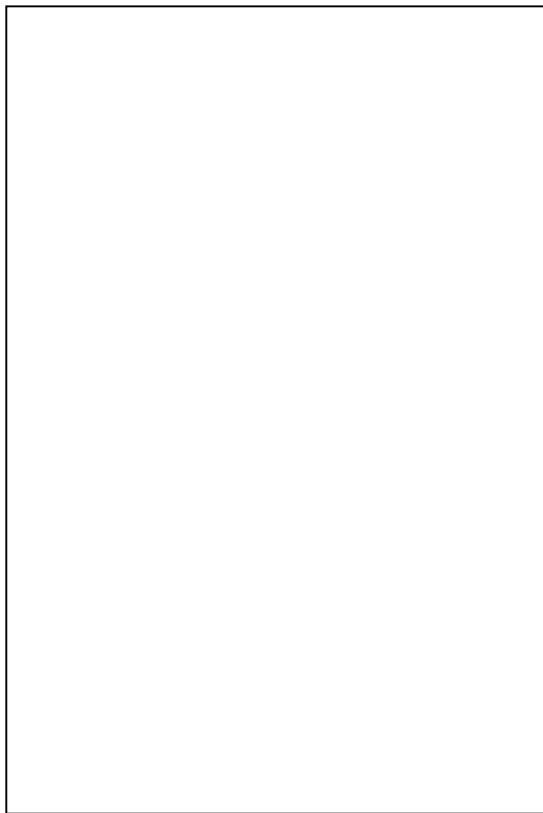

Plate 46: Truss 3

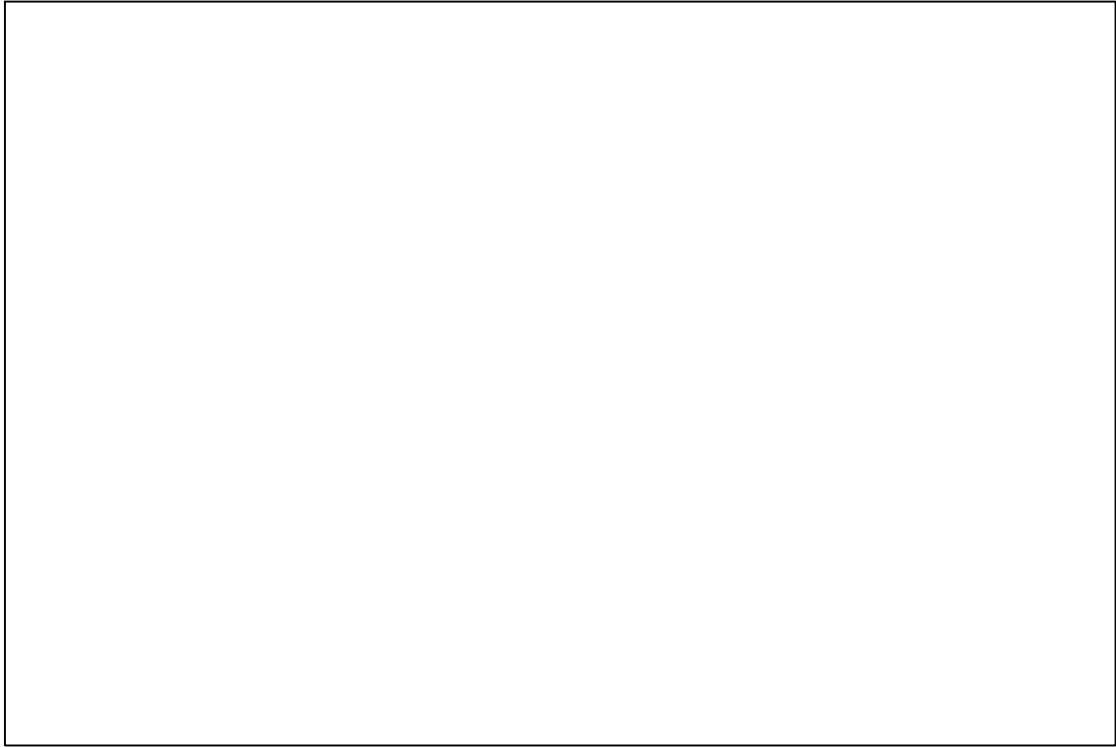

Plate 47: Part of the partition below Truss 3

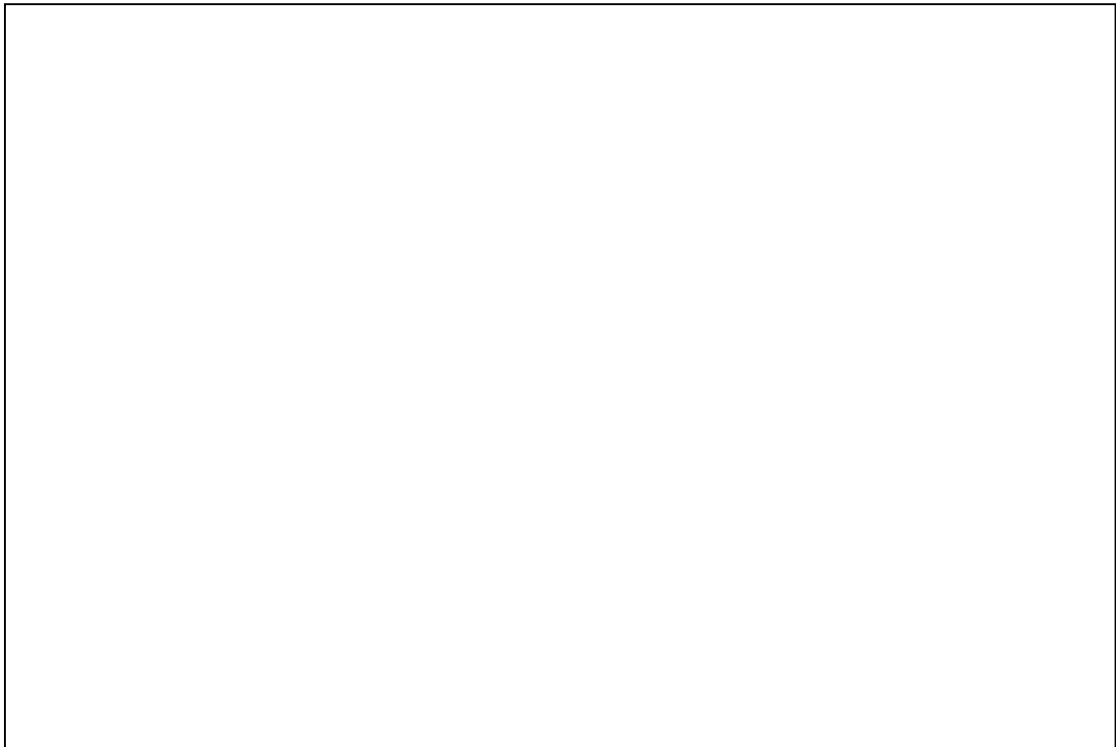

Plate 48: Door head cut into the collar of Truss 3

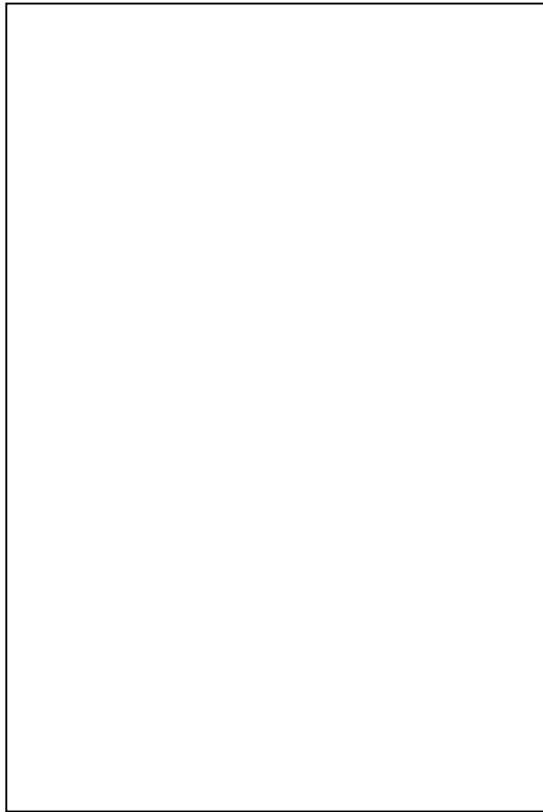

Plate 49: Truss 4



Plate 50: Chamfered edges to Truss 4

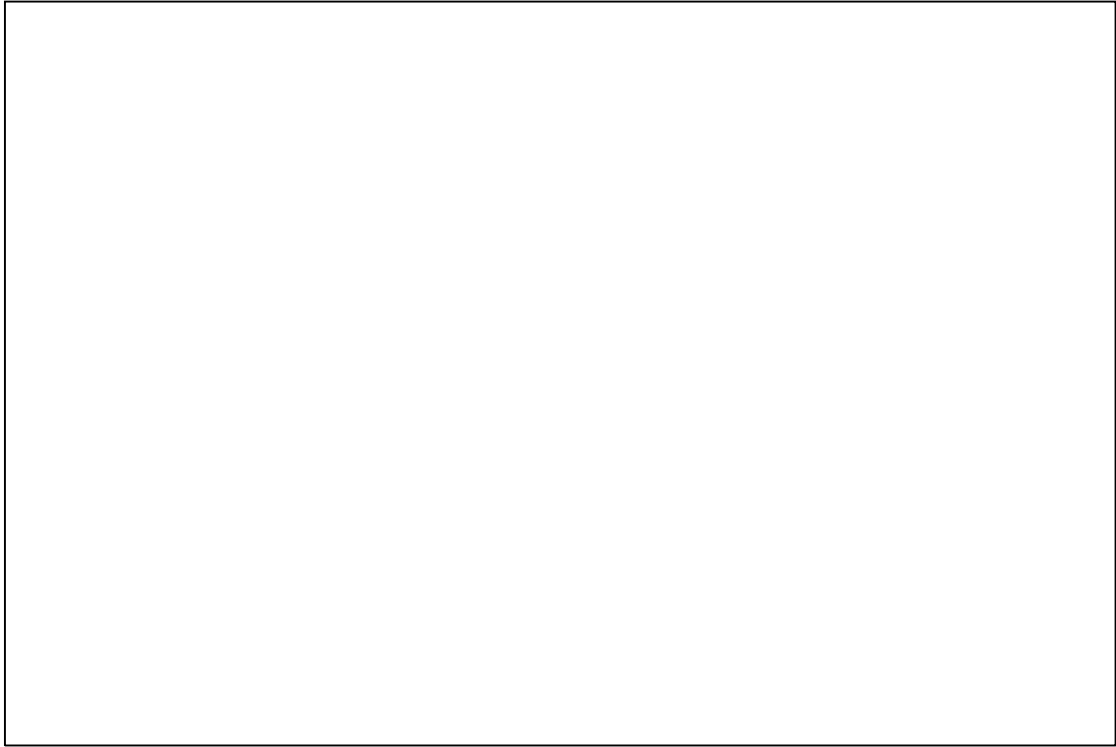

Plate 51: Trough for missing purlin, Truss 4

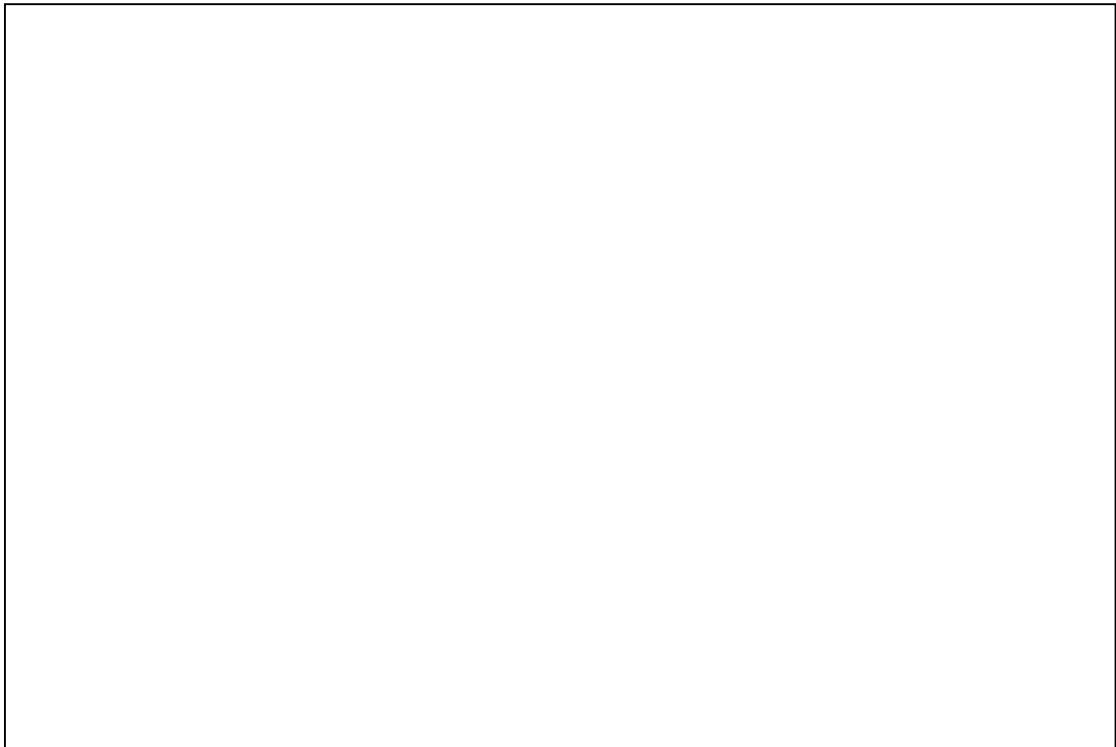

Plate 52: The rear of Truss 4 showing possible sooting

Appendix 1: Sources

Cadw Listing Information

(<http://www.coflein.gov.uk/en/site/28336/details/DDUALLT%3B+PLAS-Y-DDUALLT/>)

DDUALLT; PLAS-Y-DDUALLT

Site Details

NPRN 28336

Map Reference SH64SE
Grid Reference SH67324183
Unitary (Local) Authority Gwynedd
Old County Merioneth
Community Maentwrog
Type of Site DWELLING
Broad Class Domestic
Period 16th Century;17th Century

Site Description

Dduallt is an unusual example of the 'unit-system' of linked dwellings, in which two parallel ranges are linked by a storeyed lobby giving independent access to each. The precise relationship between the two ranges is uncertain, but the rear range of Snowdonian type is likely to be the earlier of the two on architectural grounds. The front range probably served as a parlour, but the layout suggests that it might also have been, on occasions, as a small separate dwelling. A barn or byre attached to the rear range is a later addition. The house was restored by Colonel Campbell in the 1960s when it was extensively renovated. See the discussion of the unit system in *Vernacular Architecture* 38 (2007), pp. 19-34. Plan and perspective sketch published in *Houses of the Welsh Countryside* (RCAHMW, 1975), fig. 85. (RFS/RCAHMW/APRIL 2011).

[Additional:] Tree-ring dating commissioned by North-West Wales tree-ring dating project in partnership with RCAHMW in 2010/11.

The west range was found to be the earlier of the two parts of the house, as expected. However, the felling dates for this section were widely ranging from winter 1559/60 to the spring of 1565, with a further timber dating to 1567-92. The evidence suggests that the west range was probably completed in its present form by the late 1560s. As to the East Range, many of the timbers were fast grown with insufficient rings for successful cross-dating. Of the four out of five timbers dated from this range, only two retained complete sapwood. These were the first floor tiebeams, one of which was found to have been felled in the spring of 1600, whilst the other was felled in the winter of 1604/5. Therefore, it is most likely that this range would have been constructed in or shortly after 1605. Full report available in NMRW. (NJR, 07/04/2011)

[Additional:] Tree-ring dating reported in Vernacular Architecture 42 (2011).
(RFS/RCAHMW/JULY 2011).

HER Information

http://www.cofiadurcahcymru.org.uk/arch/gat/english/gat_interface.html

Gwynedd Archaeological Trust

Regional Historic Environment Record

Dduallt House, Ffestiniog

Primary Reference Number (PRN) : 6462

Trust : Gwynedd

Site Type : HOUSE

Period : Post-Medieval

Community : Ffestiniog

NGR : SH67324183

Legal Protection :

Description :

Two parts joined by porch with unusual features. Front 18th/19th century?
rear 15th/16th century? Rough stone work, stone flight of steps to front.
Abandoned. <2>

Sources :

Nmr Record Card , Royal Commission on Ancient and Historic Monuments , ,
<1>

Rc Buildings Records , Royal Commission on Ancient and Historic
Monuments , 1999 , <2>

Events :

Related PRNs :

Coflein

(http://jura.rcahms.gov.uk/cadw/cadw_eng.php?id=4703)

Dduallt (also known as Plas y Dduallt)

Street Name and Number: ,

Listed Building Reference: 4703

Grade: II

Date Listed: 24/04/1951

Date Amended: 25/02/2005 Co-ordinates: 267313,341822

Locality: Vale of Ffestiniog

Community: Maentwrog

Council: Gwynedd

National Park: Yes

Location

In an isolated rural location raised high above the N side of the narrow country road that runs along the N side of the Vale of Ffestiniog between the A487(T) and the B4391; ENE of Maentwrog.

History

Dduallt is an unusual example of the 'unit-system' of linked dwellings, in which two parallel ranges are linked by a storeyed lobby giving independent access to each. The relationship between the two ranges is uncertain, but the rear range is likely to be the earlier of the two (the small front range has an ancillary character), though both are probably late C16. The front range is thought to have served as a parlour, but the layout suggests that it was originally a small separate dwelling. A barn or byre attached to the rear range is a later addition. The house had been abandoned at the time of the original listing survey in 1951, and was restored by Colonel Campbell in the 1960s. Associated with the house is a walled garden - rare in Merionydd. extensively renovated in the later C20.

Interior

The two elements of the house are linked by the central lobby on both floors. Rear range appears to have comprised hall with gable-end fireplace, and small unheated service room. Collared truss with arched doorhead cut into the collar. The smaller front range comprised a single room, serving as the parlour as the houses were integrated, though perhaps originally representing a small independent dwelling unit. It has a mural stair in the rear wall, the only access to the first floor of both units.

Exterior

Farmhouse, planned according to the 'unit- system' of linked dwellings, the 2 ranges here connected by a small covered court or porch. The rear unit has a barn or byre to rear and a kitchen addition at one gable; at the far end of the barn are a pair of modern single storey additions. The principal range, to front, is built of rubble masonry; slate roof with tall square stone gable stacks with dripstones and capping. Offset to L of the front lateral wall are ground and first floor windows of 3-lights, the ground floor window in a former doorway accessed by an external flight of stone steps. The present door is to far L of the range and is a narrow door with rounded head. At the R gable return windows flank the chimney at ground, 1st and attic floor level; deeply recess and housing modern timber mullioned and casement windows, attic windows retain earlier diagonally set timber mullions. The L gable return has somewhat scattered fenestration of small windows; 1st floor windows flanking the fireplace and with plain flat labels across the window heads. The porch has a segmentally headed doorway with a head of radiating stones and small window above recessed into a rectangular opening between the 2 wings; a lions head above the doorway a later addition. The rear range is a 2-storey block built of mortared rubble masonry; slate roof with tall gable stacks with dripstones and capping, that to L a massive stack. The front lateral wall (facing the front house or unit) has a single ground and first floor window close to the porch; the ground floor window is a 3-light timber casement and the first floor casement of 2-lights is set in a gabled half dormer that breaks the eaves line. There is a small window at ground floor level in the R gable return and at the L gable projecting dripstones indicate the roof line of the original single storey wing, extensively rebuilt in late C20; with modern lights, a gabled half dormer in the rear roof pitch and a large round-headed window in the end gable. The agricultural buildings to rear have been extensively modernised and extended, the barn has timber casements and french doors; the addition to rear has a glazed roof and tall round-headed windows along one lateral wall.

Reason for Listing

Listed as a fine and unusual example of sub-medieval planning, forming linked dwellings. Retains good traditional character.

References

Jones Roberts K W, Historic Houses in Ffestiniog and district, Journal of Merioneth Historical and Record Society, Volume III, 1957-1960, pp 264, 268-9; Smith J B & Smith L B, History of Merioneth Vol II - The Middle Ages, 2001, pp 458, 504-5; Smith P, Houses of the Welsh Countryside, 1988, pp 167, 178, 436-7, 472-3, 490-3, 658-6; Dolgellau Record Office, Tithe Map and Schedule of the Parish of Maentwrog, 1840; First Edition

Smith, P. 1988, *Houses of the Welsh Countryside. A study in historical Geography (Second enlarged edition)*. HMSO, London

P167. In Merioneth there is one pattern where two units are linked by a vestibule as at Dduallt (Llanfrothen) and at Argoed (Lanbedr). At Dduallt the second unit is a parlour block; at Argoed it is a second house.

P178

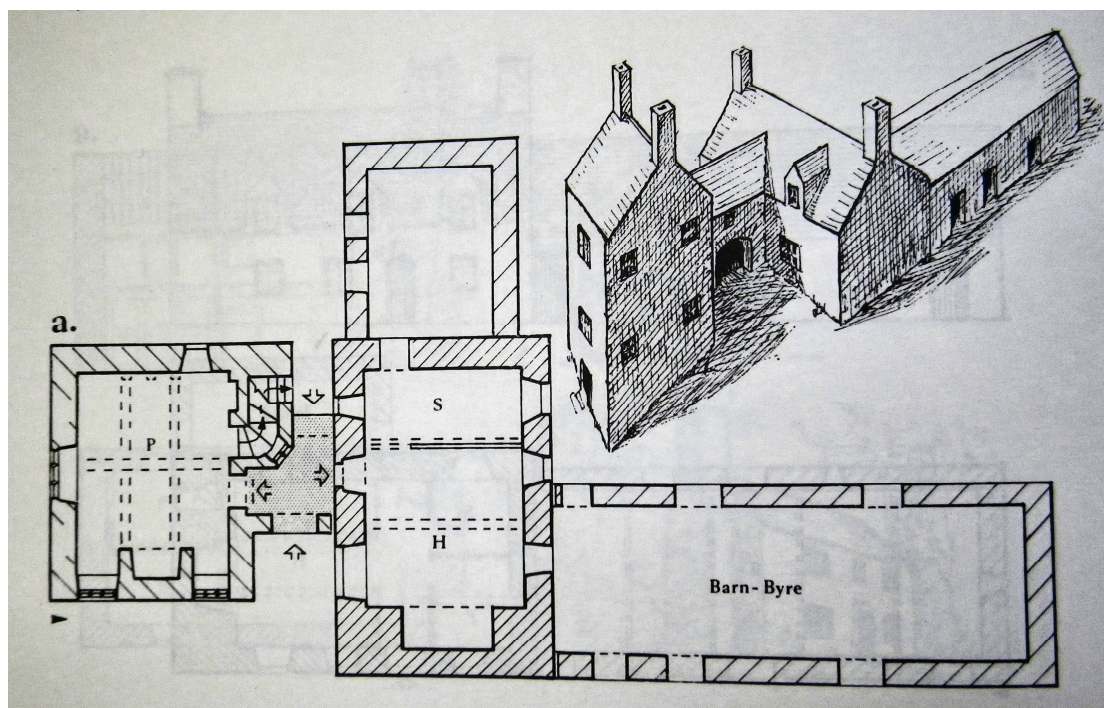

PP436-7, Regional house type A (end chimney and inside cross passage group of plans.

PP472-3, Fire place stairs

PP490-3, Post and panel partitions

PP658-6; Wooden diamond-mullioned windows

Haslam, R., Orbach, J. and Voelcker, A. 2009 *The Buildings of Wales. Gwynedd*. Yale University Press, London. 675

DUALLT, 1 m. ENE of Tan-y-bwlch. In oak woods, high on the S side of the valley. Two parallel two-storey ranges linked by a shared storeyed lobby. The N range, with a later barn to N, is probably late C16; the near-square S range, on the downhill side - considerably taller because of the attic - is perhaps early C17. It served as the parlour, though the two ranges may have been independent at one time, thus an example of the 'unit system'. The parlour range has a rear mural stair, the other interiors and many windows are of a 1960s restoration from dereliction.

Smith, P. 2001. Houses c.1415 – c.1642. In Beverley Smith, J and Beverley Smith, L (eds.) *History of Merioneth. Volume II. The Middle Ages*. Cardiff University Press, Cardiff. 422 - 506

G23 Ddualt (Maentwrog) SH 6732 4183 (Fig. 10.46-7)

These are echoes of the 'unit-system' here, where a parlour with chamber over reached by its own stair has been attached to the sub-medieval end-chimney house alongside by an entrance-hall giving independent access to the two separate units. This arrangement of common entrance-hall to two otherwise virtually separate houses is paralleled by Argoed (Llanfair) and Pennarth (Llanbedr

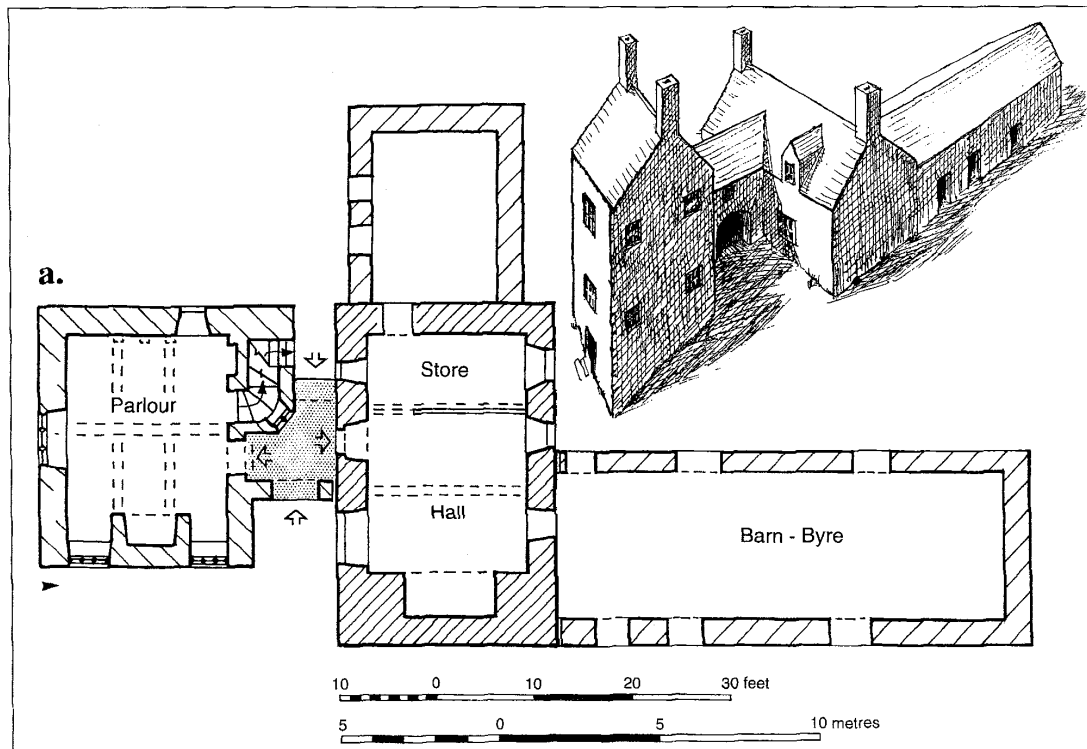

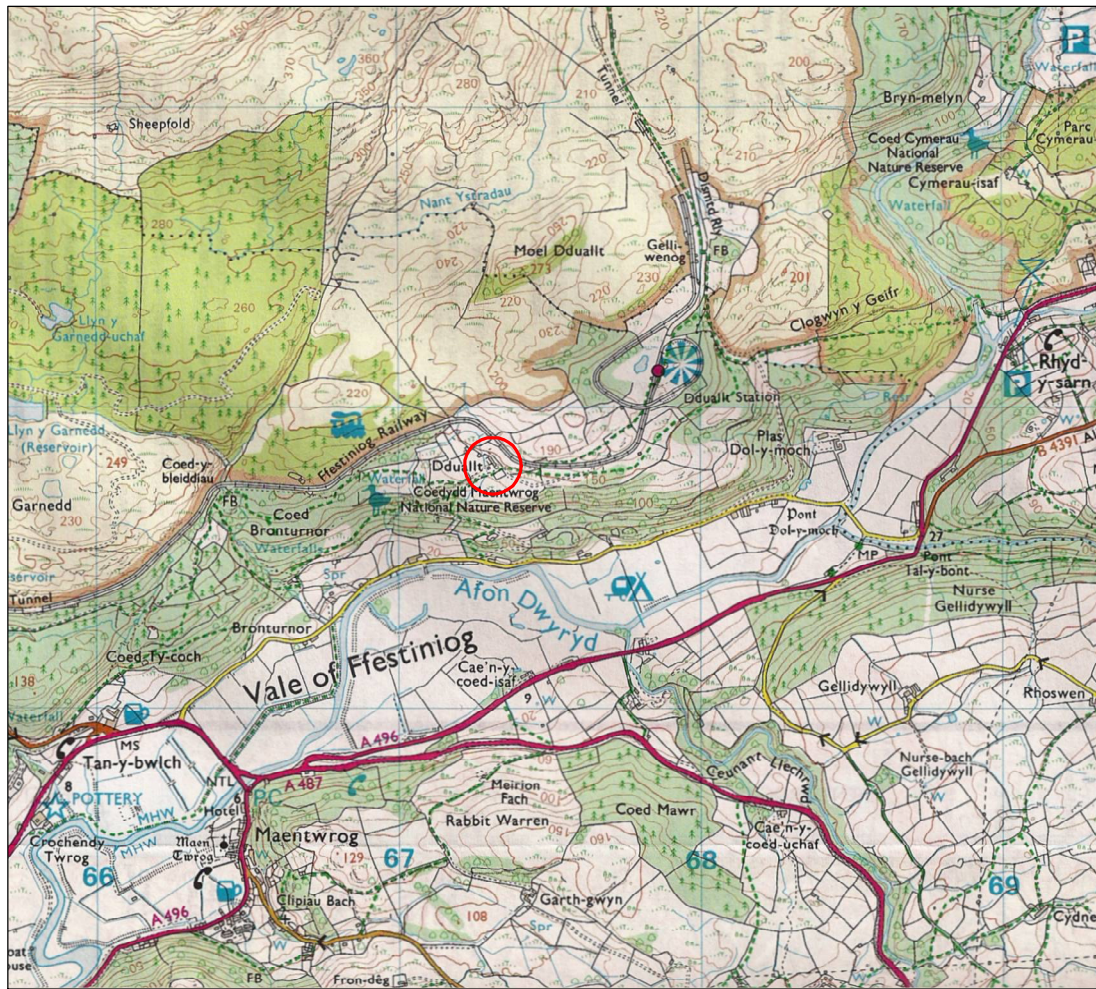

Figure 1: Location
Scale 1:25,000

Reproduced from the Explorer™ OL18, 1:25,000 scale
by permission of the Ordnance Survey ® on behalf of
The Controller of Her Majesty's Stationary Office
© Crown Copyright 2009
All Rights Reserved Licence Number AL 100014722

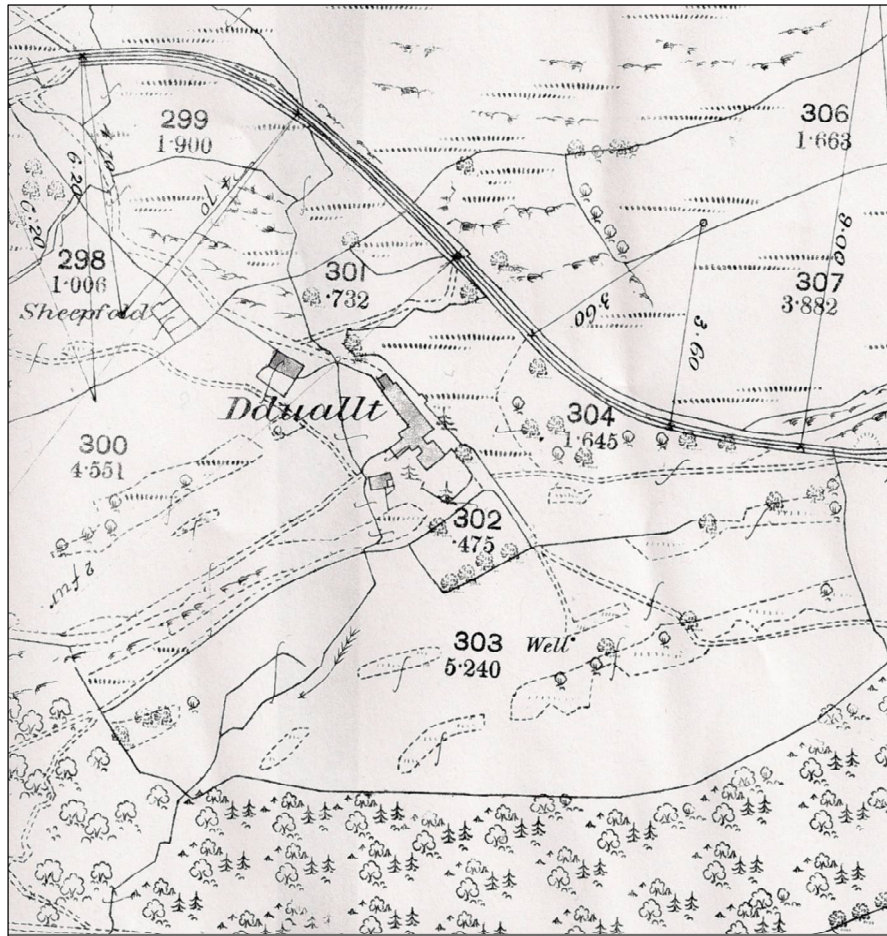

Figure 2: Extract from the 1889, First Edition Ordnance Survey
1:2500 map Merionethshire XI.8

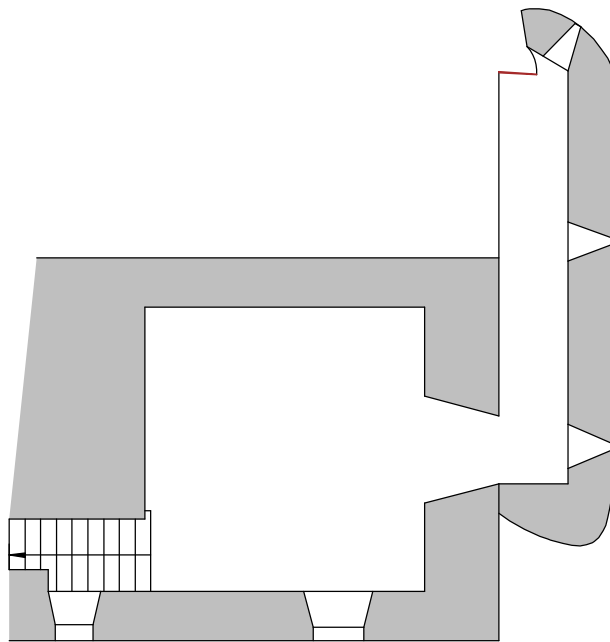
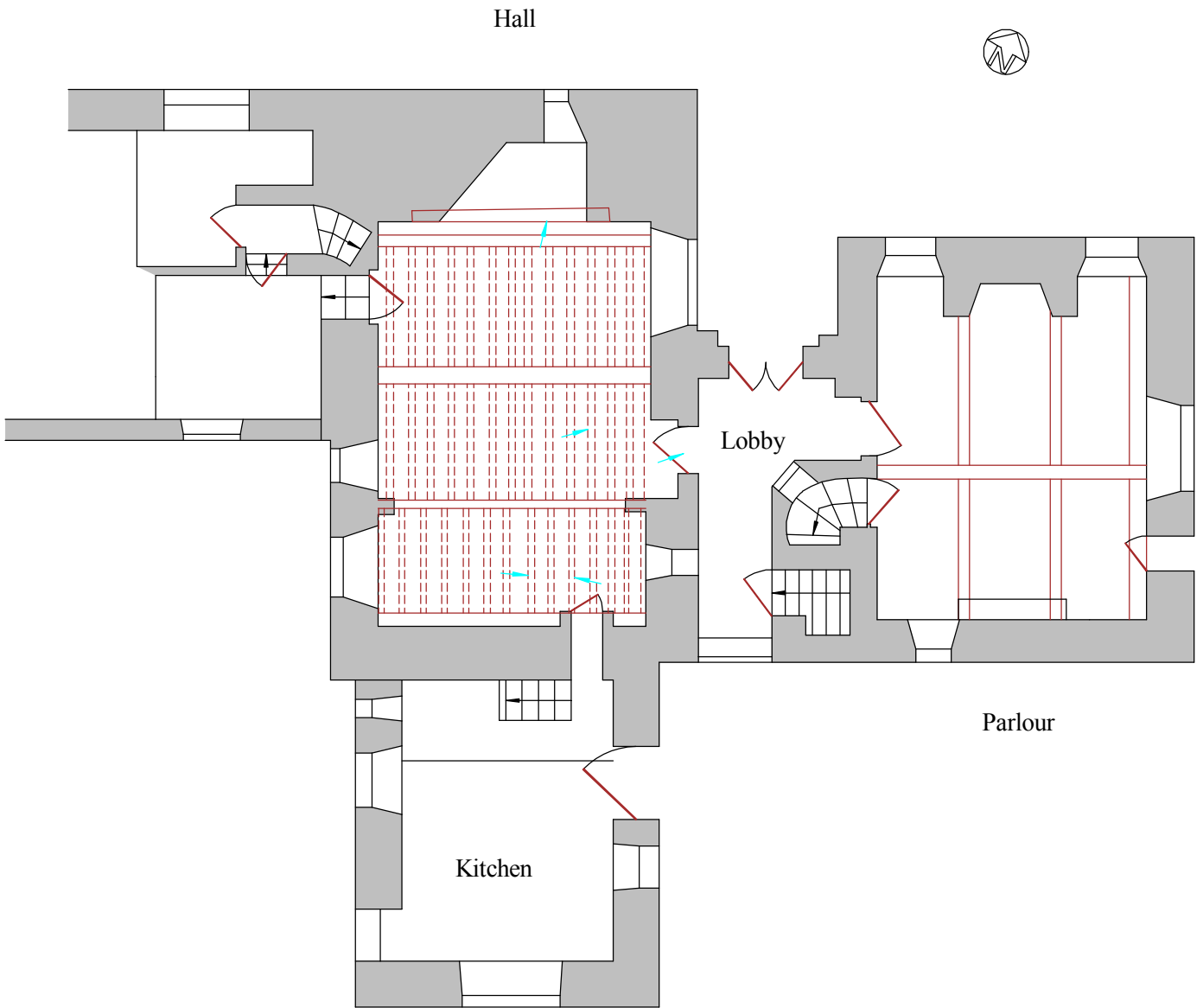

Figure 3: Plan of the Cellar
Scale 1:120



⚡ Location of the samples



Figure 4: Ground Floor Plan
Scale 1:120

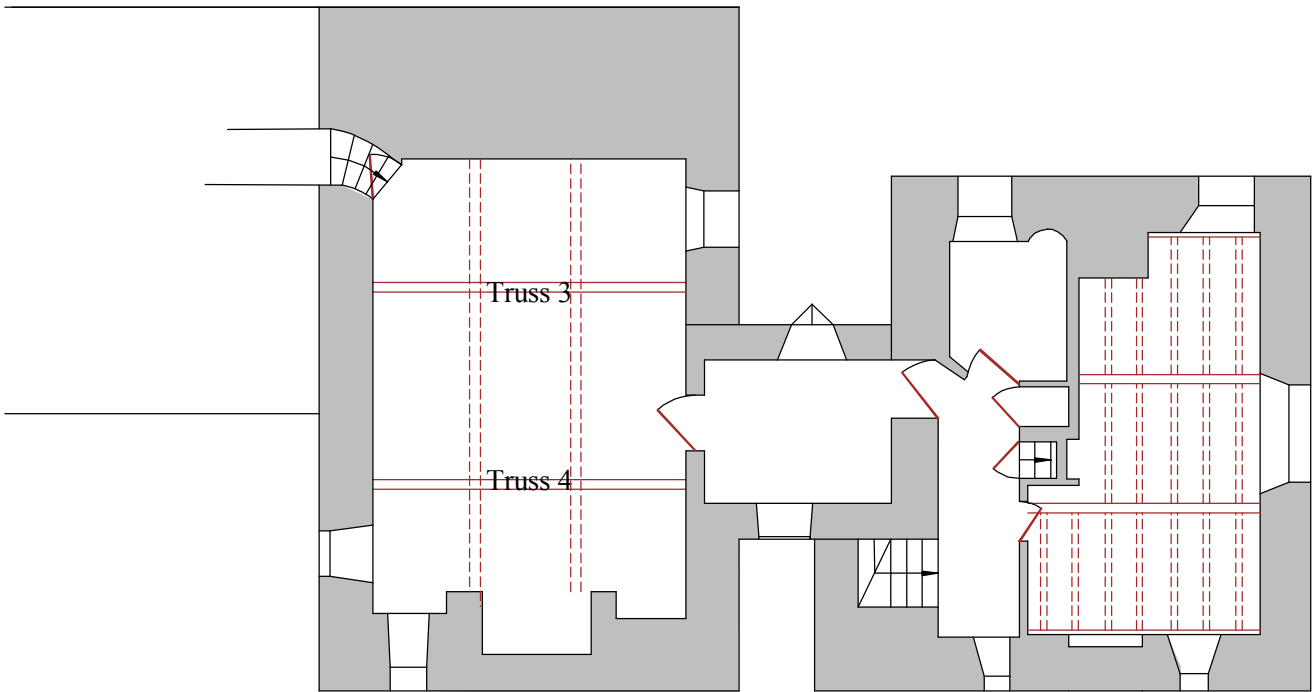

Figure 5: First Floor Plan
Scale 1:20

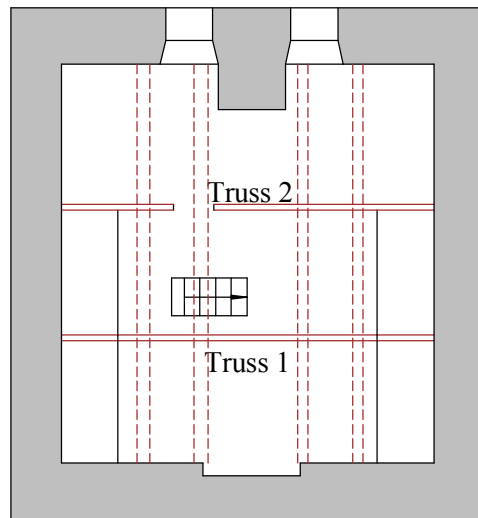

Figure 6: Attic Plan
Scale 1:120

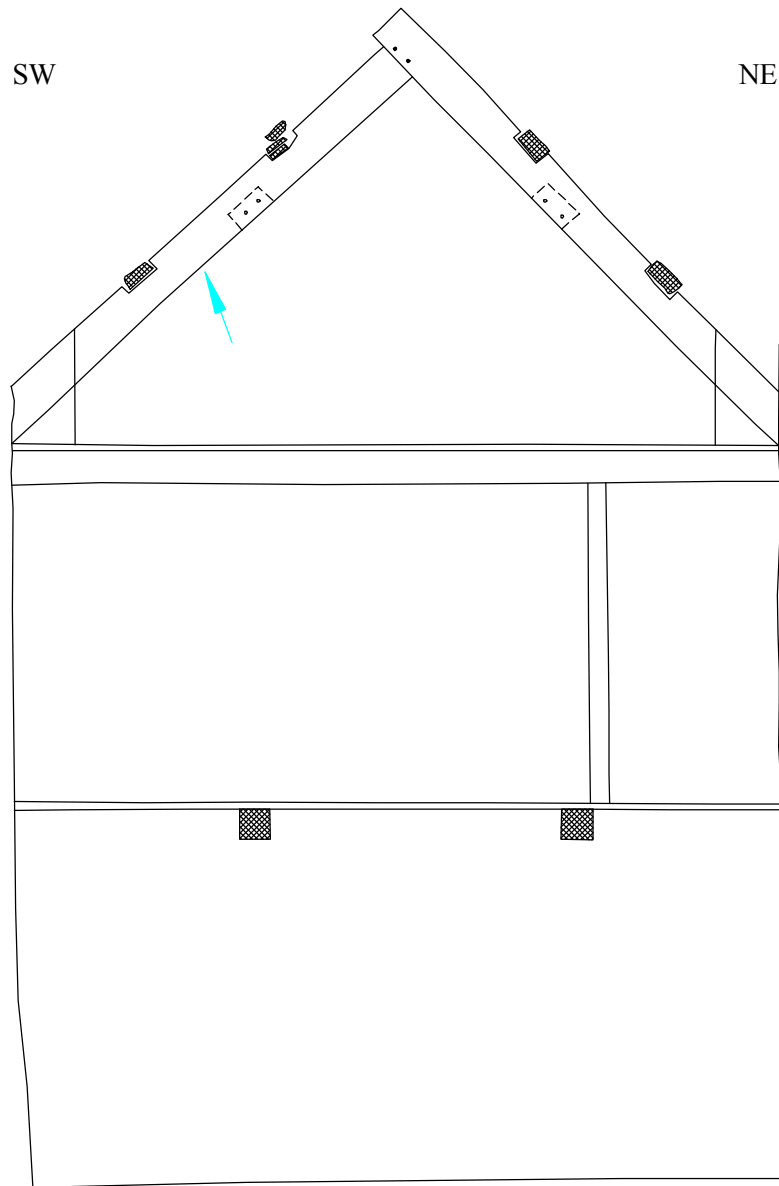
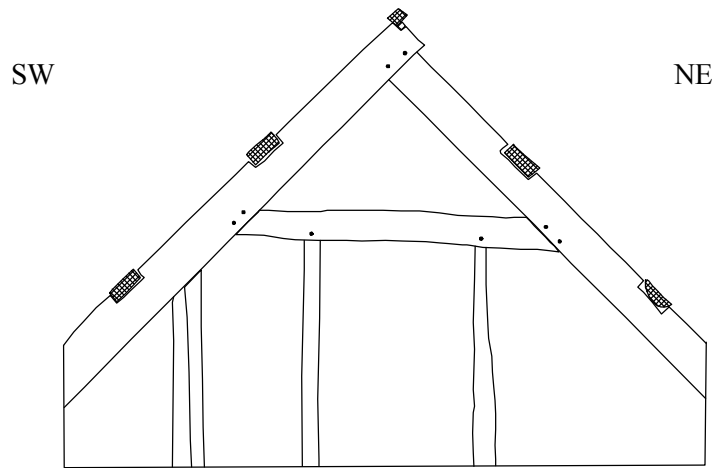
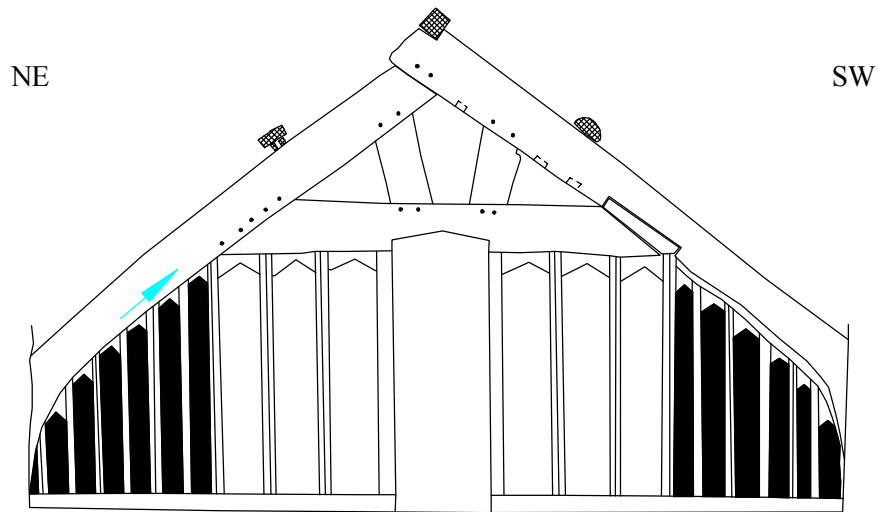

Figure 7: Truss 1
Scale 1:50





8.1: Truss 2



8.2: Truss 3

Figure 8: Trusses 2 and 3
Scale 1:50



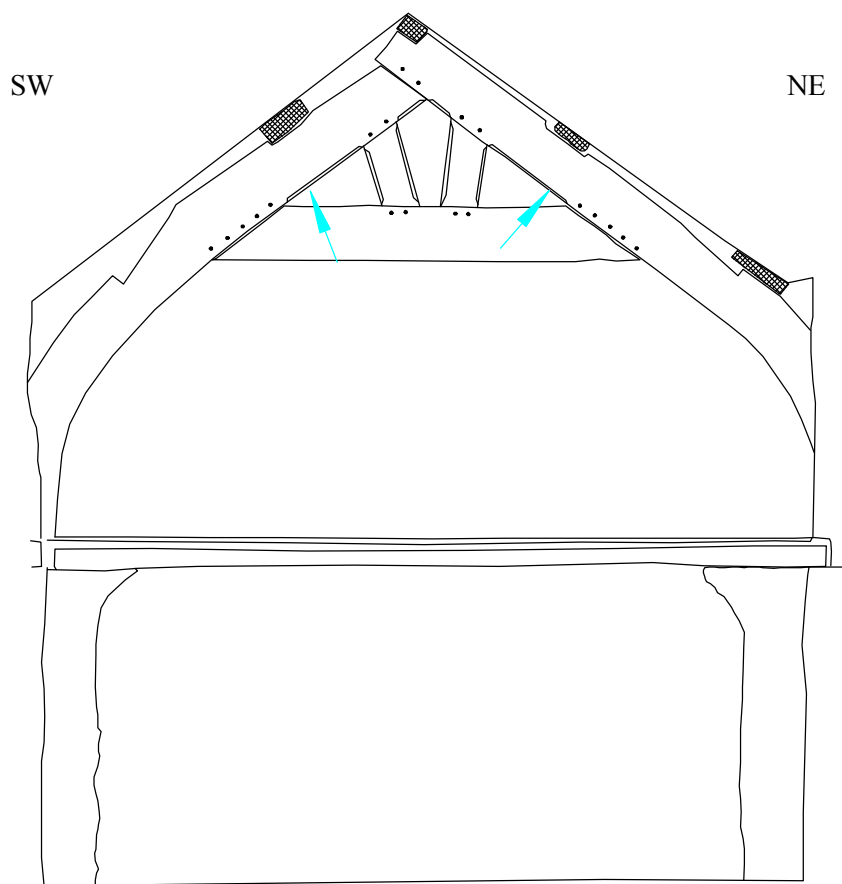

Figure 9: Truss 4
Scale 1:50



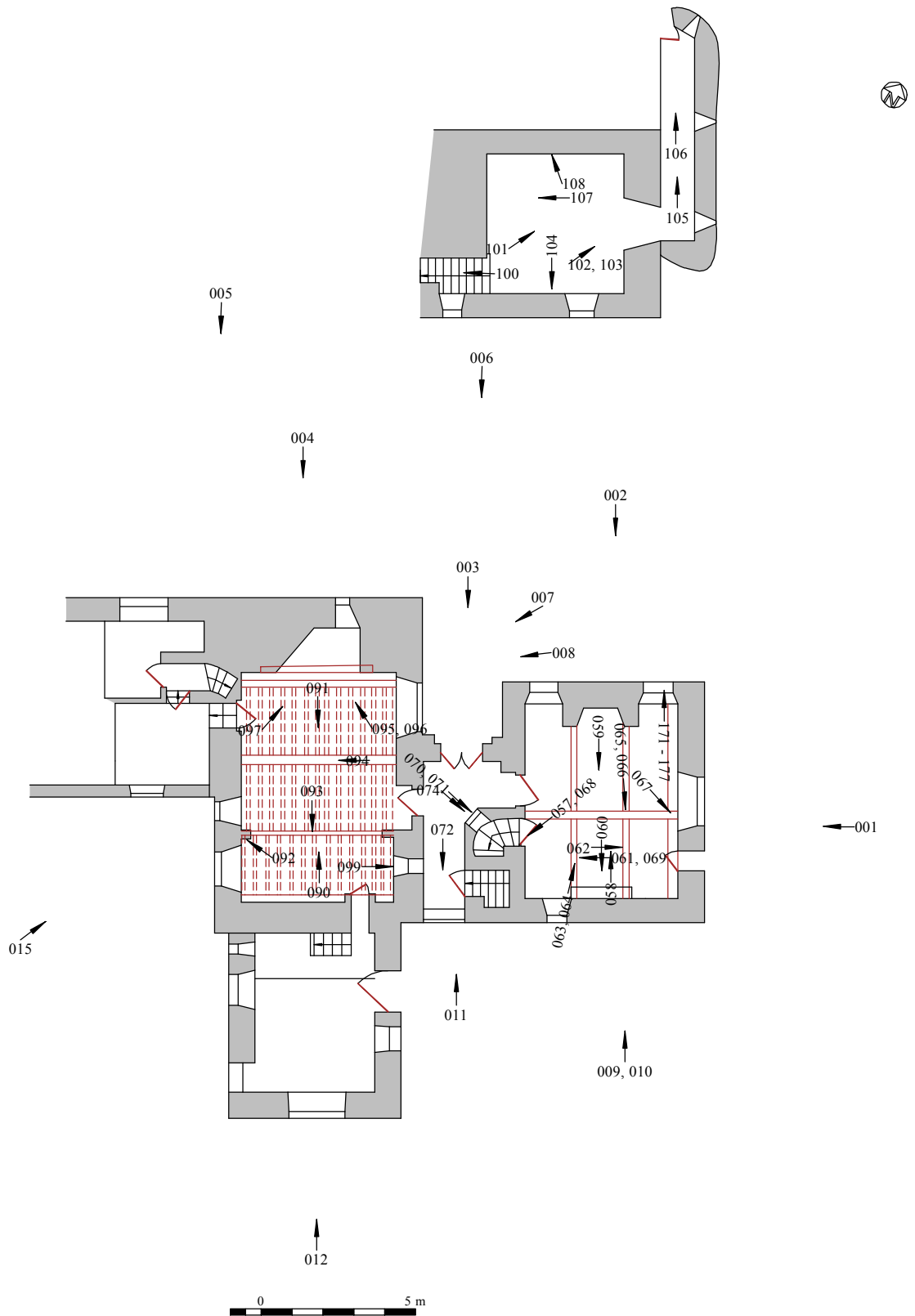

Figure 10: Location of the Photographs in the Archive
 (Cellar and Ground Floor)
 Scale 1:200

